



AUDIO PROCESSOR

■GENERAL DESCRIPTION

The **NJW1133A** is an audio processor. It includes all of functions processing audio signal for TV, such as tone control, balance, volume, mute, and AGC(Auto Gain Control) functions.

All of internal status and variables are controlled by I²C BUS interface.

■PACKAGE OUTLINE



NJW1133AM

■FEATURES

- Operating Voltage 8 to 13V
- I²C BUS Interface
- AGC Circuit (It reduces volume difference among input sources.)
- Matrix Surround
- Bi-CMOS Technology
- Package Outline SDMP30

■BLOCK DIAGRAM

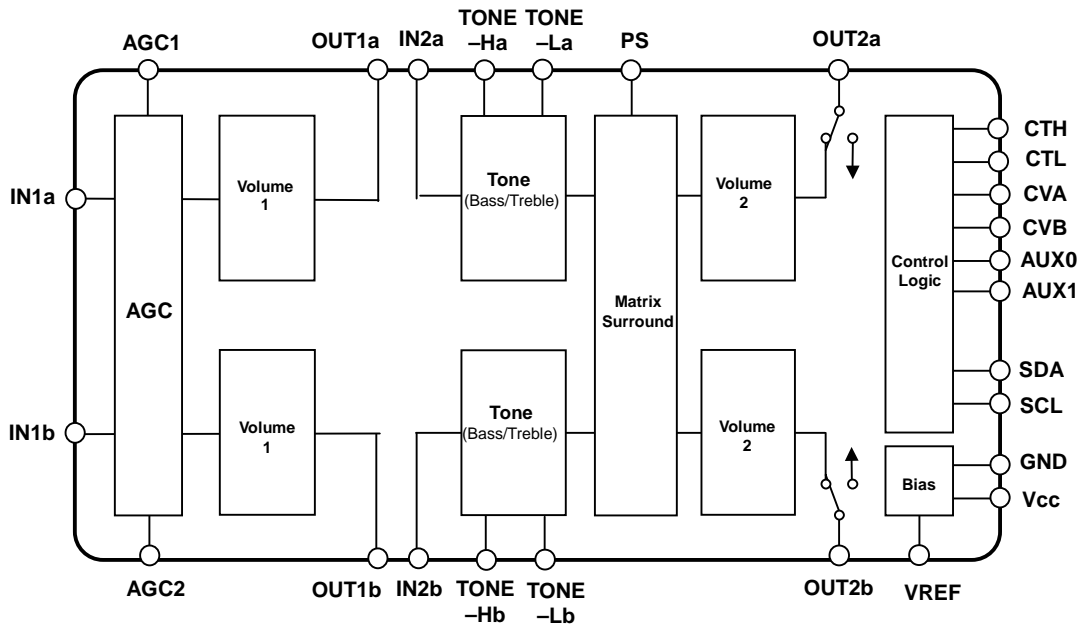

■PIN FUNCTION

1	IN1a	IN1b	30
2	NC	NC	29
3	NC	NC	28
4	OUT1a	OUT1b	27
5	IN2a	IN2b	26
6	TONE-Ha	TONE-Hb	25
7	TONE-La	TONE-Lb	24
8	OUT2a	OUT2b	23
9	AGC1	PS	22
10	AGC2	VREF	21
11	CVB	CTH	20
12	CVA	CTL	19
13	SDA	AUX0	18
14	SCL	AUX1	17
15	GND	Vcc	16

No.	Symbol	Function	No	Symbol	Function
1	IN1a	Ach Input	16	Vcc	Supply Voltage
2	NC	No Connected	17	AUX1	Auxiliary Output1
3	NC	No Connected	18	AUX0	Auxiliary Output0
4	OUT1a	Ach Output for the Other Accessories	19	CTL	DAC Output for Tone Low Frequency
5	IN2a	Ach Input From the Other Accessories	20	CTH	DAC Output for Tone High Frequency
6	TONE-Ha	Ach Treble Filter	21	VREF	Reference Voltage
7	TONE-La	Ach Bass Filter	22	PS	Surround Phase Shift Filter
8	OUT2a	Ach Output	23	OUT2b	Bch Output
9	AGC1	AGC1	24	TONE-Lb	Bch Bass Filter
10	AGC2	AGC2	25	TONE-Hb	Bch Treble Filter
11	CVB	DAC Output for Bch Volume & Balance	26	IN2b	Bch Input from the Other Accessories
12	CVA	DAC Output for Ach Volume & Balance	27	OUT1b	Bch Output for the Other Accessories
13	SDA	SDA Data Input (I ² C BUS)	28	NC	No Connected
14	SCL	SCL Data Input (I ² C BUS)	29	NC	No Connected
15	GND	GND	30	IN1b	Bch Input

■ABSOLUTE MAXIMUM RATING (Ta=25°C)

PARAMETER	SYMBOL	RATING	UNIT
Supply Voltage	V ⁺	14	V
Power Dissipation	P _D	700	mW
Operating Temperature Range	Topr	-20 to +75	°C
Storage Temperature Range	Tstg	-40 to +125	°C

■ELECTRICAL CHARACTERISTICS (Ta=25°C, V+=9V, Rg=600Ω, RL=47kΩ, Vin=100mVrms/1kHz)

PARAMETER	SYMBOL	TEST CONDITION	MIN.	TYP.	MAX.	UNIT
Operating Voltage	V ⁺		8.0	9.0	13.0	V
Supply Current	I _{CC}	No Signal	-	20	30	mA
Reference Voltage	V _{REF}	No Signal	4.0	4.5	5.0	V
Maximum Input Voltage	V _{IM}	VOL=C3H,THD=1%	2.3	2.5	-	Vrms
Maximum Output Voltage	V _{OM}	OUTPUT VOL=FFH,THD=1%	-	2.5	-	Vrms
Channel Balance	G _{CB}	VOL=FFH	-1.5	0.0	1.5	dB
Balance Boost A	BA _{BST}	CHS="0",BAL="11111"	-2.0	0.0	2.0	dB
Balance Cut A	BA _{CUT}	CHS="1",BAL="11111" Vin = 1Vrms	-	-	-70	dB
Balance Boost B	BB _{BST}	CHS="1",BAL="11111"	-2.0	0.0	2.0	dB
Balance Cut B	BB _{CUT}	CHS="0",BAL="11111" Vin = 1Vrms	-	-	-70	dB
Total Harmonic Distortion	THD	Vo=0.5Vrms BW=400Hz to 30kHz	-	-	0.5	%
Maximum Gain	G _{VMAX}	VOL=FFH(0dB)	-2.0	0.0	2.0	dB
Minimum Gain	G _{VMIN}	VOL=00H(MUTE)	-	-	-70	dB
Channel Separation	CS	Vin=2Vrms	-	-	-70	dB
Output Noise 1	V _{NO1}	VOL=FFH(0dB) BW=400Hz to 30kHz	-	-80 (100)	-70 (316)	dBV (μVrms)
Output Noise 2	V _{NO2}	VOL=00H(MUTE) BW=400Hz to 30kHz	-	-90 (31.6)	-82 (79.4)	dBV (μVrms)
AUX Output Voltage	V _{AUX}	Logic Output : High	4.5	-	5.0	V
		Logic Output : Low	0	-	0.3	

BW : Band Width

●TONE CONTROL (Ta=25°C, V⁺=9V, R_g=600Ω, R_L=47kΩ, Vin=100mVrms/1kHz)

PARAMETER	SYMBOL	TEST CONDITION	MIN.	TYP.	MAX.	UNIT
High Frequency Boost	HF _{BST}	BCT="1",TREB="1111", f=10kHz	12.5	15.0	17.5	dB
High Frequency Flat	HF _{FLT}	TREB="0000",f=10kHz	-2.0	0.0	2.0	dB
High Frequency Cut	HF _{CUT}	BCT="0",TRBE="1111", f=10kHz	-17.5	-15.0	-12.5	dB
Low Frequency Boost	LF _{BST}	BCB="1",BASS="1111", f=100Hz	12.5	15.0	17.5	dB
Low Frequency Flat	LF _{FLT}	BASS="0000",f=100Hz	-2.0	0.0	2.0	dB
Low Frequency Cut	LF _{CUT}	BCB="0",BASS="1111", f=100Hz	-17.5	-15.0	-12.5	dB
High Frequency Cut DC Offset1	HF _{DC1}	BCT="0",TREB="1111" →"0000"	-1.0	0.0	1.0	V
High Frequency Boost DC Offset2	HF _{DC2}	BCT="1",TREB="1111" →"0000"	-1.0	0.0	1.0	V
Low Frequency Cut DC Offset1	LF _{DC1}	BCB="0",BASS="1111" →"0000"	-1.0	0.0	1.0	V
Low Frequency Boost DC Offset2	LF _{DC2}	BCB="1",BASS="1111" →"0000"	-1.0	0.0	1.0	V

●SUB-TONE CONTROL (Ta=25°C, V⁺=9V, R_g=600Ω, R_L=47kΩ, Vin=100mVrms)

PARAMETER	SYMBOL	TEST CONDITION	MIN.	TYP.	MAX.	UNIT
High Frequency Boost	SHF _{BST}	BCST="0",SUB-TREB="11", f=10kHz	2.0	3.0	4.0	dB
High Frequency Flat	SHF _{FLT}	SUB-TREB="00",f=10kHz	-2.0	0.0	2.0	dB
High Frequency Cut	SHF _{CUT}	BCST="0",SUB-TREB="11", f=10kHz	-4.0	-3.0	-2.0	dB
Low Frequency Boost	SLF _{BST}	BCSB="1",SUB-BASS="11", f=100Hz	2.0	3.0	4.0	dB
Low Frequency Flat	SLF _{FLT}	SUB-BASS="00",f=100Hz	-2.0	0.0	2.0	dB
Low Frequency Cut	SLF _{CUT}	BCSB="1",SUB-BASS="11", f=100Hz	-4.0	-3.0	-2.0	dB

●AGC CONTROL: AGC=1H (AGC-ON) (Ta=25°C, V⁺=9V, R_g=600Ω, R_L=47kΩ)

PARAMETER	SYMBOL	TEST CONDITION	MIN.	TYP.	MAX.	UNIT
AGC BOOST	AGC _{BST}	Vin=50mVrms, f=1kHz	1.5	3.5	5.5	dB
AGC FLAT	AGC _{FLT}	Vin=150mVrms, f=1kHz	-2.5	0.0	2.5	dB
AGC CUT	AGC _{CUT}	Vin=2Vrms, f=1kHz	-14	-10	-6.0	dB

●SURROUND CONTROL (Ta=25°C, V⁺=9V, R_g=600Ω, R_L=47kΩ, Vin=100mVrms/1kHz)

PARAMETER	SYMBOL	TEST CONDITION	MIN.	TYP.	MAX.	UNIT
SURROUND MIX 1	SR _{MIX1}	Ain → Bout	-2.0	0.0	2.0	dB
SURROUND MIX 2	SR _{MIX2}	Bin → Aout	-2.0	0.0	2.0	dB
SURROUND DEF	SR _{DEF}	Ain-Bin(-180deg)	8.0	10.0	12.0	dB
DC Offset	SR _{DC}	SUR="0" →"1"	-1.0	0.0	1.0	V

APPLICATION CIRCUIT

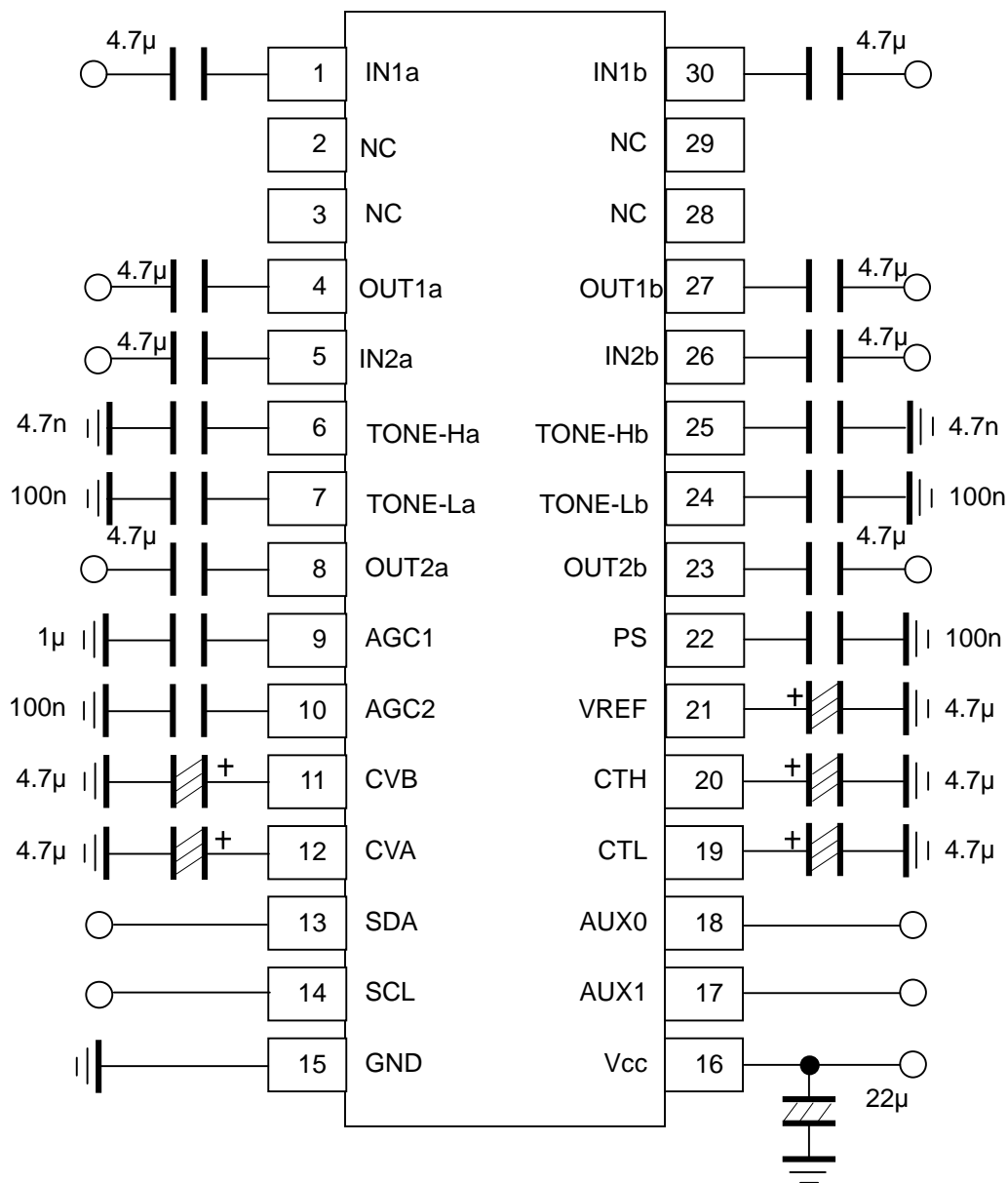

NJW1133A

■I²C BUS CHARACTERISTICS (SDA,SCL)

PARAMETER	SYMBOL	MIN.	TYP.	MAX.	UNIT
High Level Input Voltage	V _{IH}	3.0	-	5.0	V
Low Level Input Voltage	V _{IL}	0	-	1.5	V
High Level Input Current	I _{IH}	-	-	10	μA
Low Level Input Current	I _{IL}	-	-	10	μA
Low Level Output Voltage (3mA at SDA pin)	V _{OL}	0	-	0.4	V
Maximum Output Current	I _{OL}	-3.0	-	-	mA
Maximum Clock Frequency	f _{SCL}	0	-	100	kHz
Data Change Minimum Waiting Time	t _{BUF}	4.7	-	-	μs
Data Transfer Start Minimum Waiting Time	t _{HD:STA}	4.0	-	-	μs
Low Level Clock Pulse Width	t _{LOW}	4.7	-	-	μs
High Level Clock Pulse Width	T _{HIGH}	4.0	-	-	μs
Minimum Start Preparation Waiting Time	t _{SU:STA}	4.7	-	-	μs
Minimum Data Hold Time	t _{HD:DAT}	5.0	-	-	μs
Minimum Data Preparation Time	t _{SU:DAT}	250	-	-	ns
Rise Time	t _R	-	-	1.0	μs
Fall Time	t _F	-	-	300	ns
Minimum Stop Preparation Waiting Time	t _{SU:STO}	4.7	-	-	μs

*I²C BUS Load Condition: Pull up resistance 4kΩ (Connected to +5V)
Load capacitance 200pF (Connected to GND)

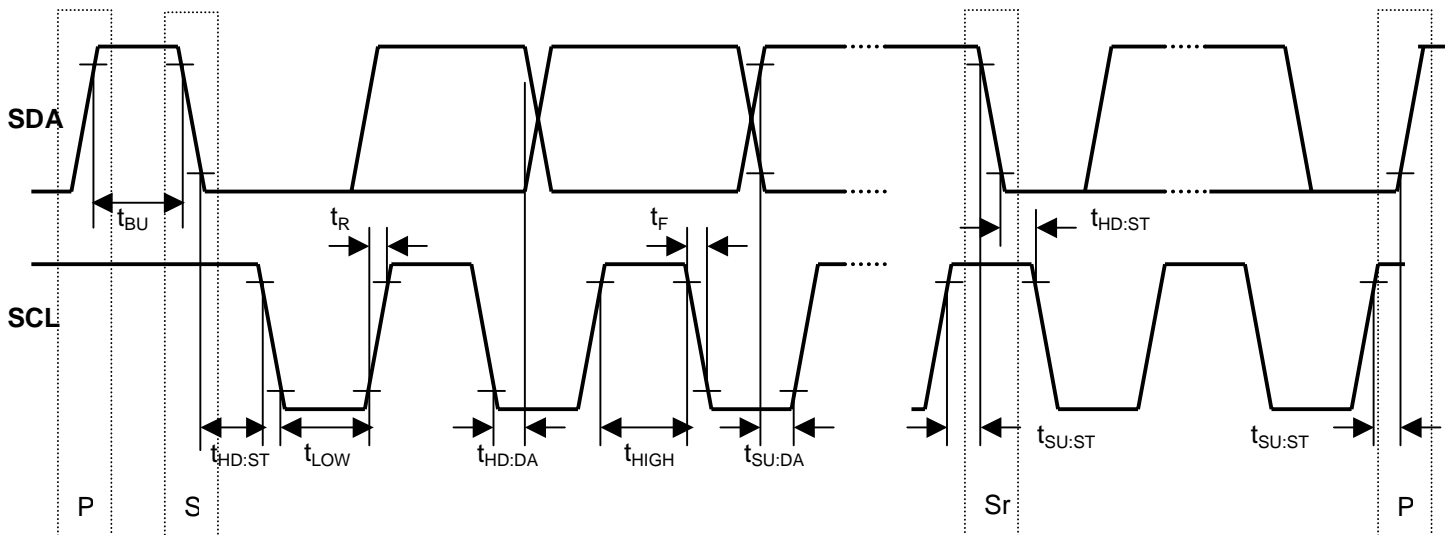

■ DEFINITION OF I²C BUS REGISTER

● I²C BUS FORMAT

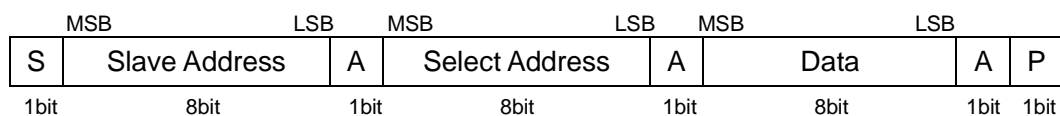

S: Starting Term

A: Acknowledge

P: Ending Term

● SLAVE ADDRESS

	MSB						LSB
1	0	0	0	0	0	1	R/W

R/W=0: Slave Receive

R/W=1: Not Output Data

● CONTROL REGISTER TABLE

The select address sets each function (Volume, Balance, AGC, Surround, Tone Control, AUX)

The auto increment function cycles the select address as follows.

00H → 01H → 02H → 03H → 04H → 05H → 00H

Select Address	BIT							
	D7	D6	D5	D4	D3	D2	D1	D0
00H	VOL							
01H	CHS	BAL				AGC	SUR	
02H	BCB	BASS			BCSB	SUB-BASS		
03H	BCT	TREB			BCST	SUB-TREB		
04H	Don't Care							
05H	OUT	Don't care				AUX1	AUX0	

● CONTROL REGISTER DEFAULT VALUE

Control register default value is all "0".

Select Address	BIT							
	D7	D6	D5	D4	D3	D2	D1	D0
00H	0	0	0	0	0	0	0	0
01H	0	0	0	0	0	0	0	0
02H	0	0	0	0	0	0	0	0
03H	0	0	0	0	0	0	0	0
04H	Don't Care							
05H	0	0	0	0	0	0	0	0

Send the I²C BUS data after 30 ms from turn on.

■INSTRUCTION CODE

a) MASTER VOLUME SETTING

Select Address	BIT							
	D7	D6	D5	D4	D3	D2	D1	D0
00H	VOL							

The volume control for both Ach and Bch(0.33dB/step).

The volume is consisted of volume1 and volume2 and the level is divided into half to each volume1 and volume2.

b) BALANCE, AGC AND SURROUND SETTING

Select Address	BIT							
	D7	D6	D5	D4	D3	D2	D1	D0
01H	CHS	BAL					AGC	SUR

- CHS : Channel select for balance control

“0” : Ach “Bch is attenuated”

“1” : Bch “Ach is attenuated”

- BAL : Balance control for both Ach and Bch(1dB/Step)

The balance is consisted of volume1 and volume2 and the level is divided into half to each volume1 and volume2.

- AGC : AGC switch

“0” : AGC OFF

“1” : AGC ON

- SUR : Surround mode switch

“0” : Surround OFF

“1” : Surround ON

c)TONE CONTROL BASS SETTING

Select Address	BIT							
	D7	D6	D5	D4	D3	D2	D1	D0
02H	BCB	BASS				BCSB	SUB-BASS	

- BCB : Boost cut select for Bass control

“0” : Cut

“1” : Boost

- BASS: BASS control(1dB/Step)

- BCSB : Boost cut select for SUB-BASS control

“0” : Cut

“1” : Boost

- SUB-BASS: SUB- BASS control(1dB/Step)

d) TONE CONTROL TREBLE SETTING

Select Address	BIT								
	D7	D6	D5	D4	D3	D2	D1	D0	
03H	BCT	TREB				BCST	SUB-TREB		

- BCT : Boost cut select for Treble control
 "0" : Cut
 "1" : Boost
- TREB: Treble control(1dB/step)
- BCST : Boost cut select for Sub-Treble control
 "0" : Cut
 "1" : Boost
- SUB-TREB: Sub-Treble control(1dB/step)

e) OUTPUT AND AUXILIARY SETTING

Select Address	BIT								
	D7	D6	D5	D4	D3	D2	D1	D0	
05H	OUT	Don't Care					AUX1	AUX0	

- OUT: ON/OFF Switch for OUTPUT
 "0" : OFF
 "1" : ON
- AUX1/AUX2: Auxiliary port High/Low
 "0" : Logic output "Low"
 "1" : Logic output "High"

■MASTER VOLUME (Select Address : 00H)

Gain (dB)	HEX	VOL							
		D7	D6	D5	D4	D3	D2	D1	D0
0	FF	1	1	1	1	1	1	1	1
-1	FC	1	1	1	1	1	1	0	0
-2	F9	1	1	1	1	1	0	0	1
-3	F6	1	1	1	1	0	1	1	0
-4	F3	1	1	1	1	0	0	1	1
-5	F0	1	1	1	1	0	0	0	0
-6	ED	1	1	1	0	1	1	0	1
-7	EA	1	1	1	0	1	0	1	0
-8	E7	1	1	1	0	0	1	1	1
-9	E4	1	1	1	0	0	1	0	0
-10	E1	1	1	1	0	0	0	0	1
-11	DE	1	1	0	1	1	1	1	0
-12	DB	1	1	0	1	1	0	1	1
-13	D8	1	1	0	1	1	0	0	0
-14	D5	1	1	0	1	0	1	0	1
-15	D2	1	1	0	1	0	0	1	0
-16	CF	1	1	0	0	1	1	1	1
-17	CC	1	1	0	0	1	1	0	0
-18	C9	1	1	0	0	1	0	0	1
-19	C6	1	1	0	0	0	1	1	0
-20	C3	1	1	0	0	0	0	1	1
-21	C0	1	1	0	0	0	0	0	0
-22	BD	1	0	1	1	1	1	0	1
-23	BA	1	0	1	1	1	0	1	0
-24	B7	1	0	1	1	0	1	1	1
-25	B4	1	0	1	1	0	1	0	0
-26	B1	1	0	1	1	0	0	0	1
-27	AE	1	0	1	0	1	1	1	0
-28	AB	1	0	1	0	1	0	1	1
-29	A8	1	0	1	0	1	0	0	0
-30	A5	1	0	1	0	0	1	0	1
-31	A2	1	0	1	0	0	0	1	0
-32	9F	1	0	0	1	1	1	1	1
-33	9C	1	0	0	1	1	1	0	0
-34	99	1	0	0	1	1	0	0	1
-35	96	1	0	0	1	0	1	1	0
-36	93	1	0	0	1	0	0	1	1
-37	90	1	0	0	1	0	0	0	0
-38	8D	1	0	0	0	1	1	0	1
-39	8A	1	0	0	0	1	0	1	0
-40	87	1	0	0	0	0	1	1	1
-41	84	1	0	0	0	0	1	0	0
-42	81	1	0	0	0	0	0	0	1

		VOL							
Gain (dB)	HEX	D7	D6	D5	D4	D3	D2	D1	D0
-43	7E	0	1	1	1	1	1	1	0
-44	7B	0	1	1	1	1	0	1	1
-45	78	0	1	1	1	1	0	0	0
-46	75	0	1	1	1	0	1	0	1
-47	72	0	1	1	1	0	0	1	0
-48	6F	0	1	1	0	1	1	1	1
-49	6C	0	1	1	0	1	1	0	0
-50	69	0	1	1	0	1	0	0	1
-51	66	0	1	1	0	0	1	1	0
-52	63	0	1	1	0	0	0	1	1
-53	60	0	1	1	0	0	0	0	0
-54	5D	0	1	0	1	1	1	0	1
-55	5A	0	1	0	1	1	0	1	0
-56	57	0	1	0	1	0	1	1	1
-57	54	0	1	0	1	0	1	0	0
-58	51	0	1	0	1	0	0	0	1
-59	4E	0	1	0	0	1	1	1	0
-60	4B	0	1	0	0	1	0	1	1
-61	48	0	1	0	0	1	0	0	0
-62	45	0	1	0	0	0	1	0	1
-63	42	0	1	0	0	0	0	1	0
-64	3F	0	0	1	1	1	1	1	1
-65	3C	0	0	1	1	1	1	0	0
-66	39	0	0	1	1	1	0	0	1
-67	36	0	0	1	1	0	1	1	0
-68	33	0	0	1	1	0	0	1	1
-69	30	0	0	1	1	0	0	0	0
-70	2D	0	0	1	0	1	1	0	1
-71	2A	0	0	1	0	1	0	1	0
-72	27	0	0	1	0	0	1	1	1
-73	24	0	0	1	0	0	1	0	0
-74	21	0	0	1	0	0	0	0	1
-75	1E	0	0	0	1	1	1	1	0
-76	1B	0	0	0	1	1	0	1	1
-77	18	0	0	0	1	1	0	0	0
-78	15	0	0	0	1	0	1	0	1
-79	12	0	0	0	1	0	0	1	0
-80	0F	0	0	0	0	1	1	1	1
-81	0C	0	0	0	0	1	1	0	0
-82	09	0	0	0	0	1	0	0	1
-83	06	0	0	0	0	0	1	1	0
-84	03	0	0	0	0	0	0	1	1
Mute	00	0	0	0	0	0	0	0	0

NJW1133A

■BALANCE(Select Address : 01H)

Channel Select (CHS)	D7
Ach	0
Bch	1

Gain(dB)	BAL				
	D6	D5	D4	D3	D2
0	0	0	0	0	0
-1	0	0	0	0	1
-2	0	0	0	1	0
-3	0	0	0	1	1
-4	0	0	1	0	0
-5	0	0	1	0	1
-6	0	0	1	1	0
-7	0	0	1	1	1
-8	0	1	0	0	0
-9	0	1	0	0	1
-10	0	1	0	1	0
-11	0	1	0	1	1
-12	0	1	1	0	0
-13	0	1	1	0	1
-14	0	1	1	1	0
-15	0	1	1	1	1
-16	1	0	0	0	0
-17	1	0	0	0	1
-18	1	0	0	1	0
-19	1	0	0	1	1
-20	1	0	1	0	0
-21	1	0	1	0	1
-22	1	0	1	1	0
-23	1	0	1	1	1
-24	1	1	0	0	0
-25	1	1	0	0	1
-26	1	1	0	1	0
-27	1	1	0	1	1
-28	1	1	1	0	0
-29	1	1	1	0	1
-30	1	1	1	1	0
Mute	1	1	1	1	1

■TONE CONTROL BASS (Select Address : 02H)

	BCB
Bass Cut or Boost	D7
Cut	0
Boost	1

		BASS			
Cut Gain(dB)	Boost Gain(dB)	D6	D5	D4	D3
-15	15	1	1	1	1
-14	14	1	1	1	0
-13	13	1	1	0	1
-12	12	1	1	0	0
-11	11	1	0	1	1
-10	10	1	0	1	0
-9	9	1	0	0	1
-8	8	1	0	0	0
-7	7	0	1	1	1
-6	6	0	1	1	0
-5	5	0	1	0	1
-4	4	0	1	0	0
-3	3	0	0	1	1
-2	2	0	0	1	0
-1	1	0	0	0	1
0	0	0	0	0	0

■TONE CONTROL SUB-BASS (Select Address : 02H)

	BCSB
Sub-Bass Cut or Boost	D2
Cut	0
Boost	1

		SUB-BASS	
Cut Gain(dB)	Boost Gain(dB)	D1	D0
-3	3	1	1
-2	2	1	0
-1	1	0	1
0	0	0	0

■TONE CONTROL TREBLE (Select Address : 03H)

		BCT
Treble Cut or Boost		D7
Cut		0
Boost		1

		TREB			
Cut Gain(dB)	Boost Gain(dB)	D6	D5	D4	D3
-15	15	1	1	1	1
-14	14	1	1	1	0
-13	13	1	1	0	1
-12	12	1	1	0	0
-11	11	1	0	1	1
-10	10	1	0	1	0
-9	9	1	0	0	1
-8	8	1	0	0	0
-7	7	0	1	1	1
-6	6	0	1	1	0
-5	5	0	1	0	1
-4	4	0	1	0	0
-3	3	0	0	1	1
-2	2	0	0	1	0
-1	1	0	0	0	1
0	0	0	0	0	0

■TONE CONTROL SUB-TREBLE (Select Address : 03H)



		BCST
Sub-Treble Cut or Boost		D2
Cut		0
Boost		1

		SUB-TREB	
Cut Gain(dB)	Boost Gain(dB)	D1	D0
-3	3	1	1
-2	2	1	0
-1	1	0	1
0	0	0	0

■TERMINAL DESCRIPTION

No.	SYMBOL	FUNCTION	EQUIVALENT CIRCUIT	VOLTAGE
1 30	IN1a IN1b	Input Pin		VCC/2
4 27	OUT1a OUT1b	Output for the Other Accessories		VCC/2
5 26	IN2a IN2b	Input From the Other Accessories		VCC/2
6 25	TONE-Ha TONE-Hb	A/Bch Treble Filter		VCC/2

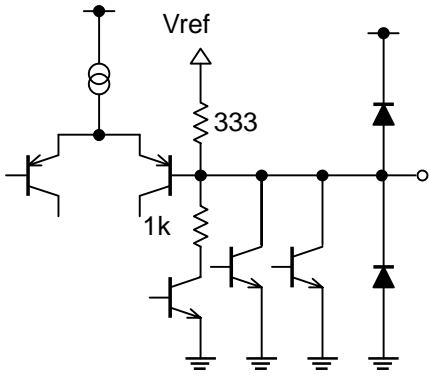
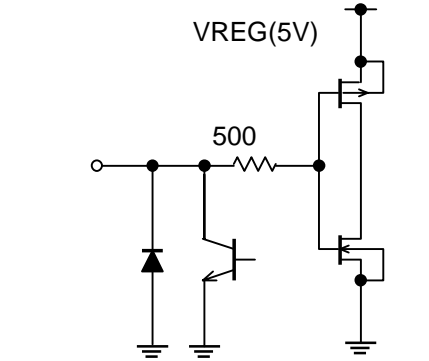
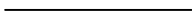
No.	SYMBOL	FUNCTION	EQUIVALENT CIRCUIT	VOLTAGE
7 24	TONE-La TONE-Lb	A/Bch Bass Filter		VCC/2
8 23	OUT2a OUT2b	Output Pin		VCC/2
9	AGC1	AGC1		0.7V
10	AGC2	AGC2		VCC/2

No.	SYMBOL	FUNCTION	EQUIVALENT CIRCUIT	VOLTAGE
11 12	CVB CVA	DAC Output for A/Bch Volume & Balance		1.4V
13 14	SDA SCL	SDA Data Input (I ² C BUS) SCL Data Input (I ² C BUS)		-
15	GND	GND Pin		-
16	VCC	Voltage Supply Pin		-

No.	SYMBOL	FUNCTION	EQUIVALENT CIRCUIT	VOLTAGE
17 18	AUX1 AUX0	Auxiliary Output		5V 0V
19 20	CTL CTH	DAC Output for Tone Low Frequency DAC Output for Tone High Frequency		1.4V
21	VREF	Reference Voltage		VCC/2
22	PS	Surround Phase Shift Filter		VCC/2

■ TYPICAL CHARACTERISTICS

Operating Current vs Operating Voltage
No Signal

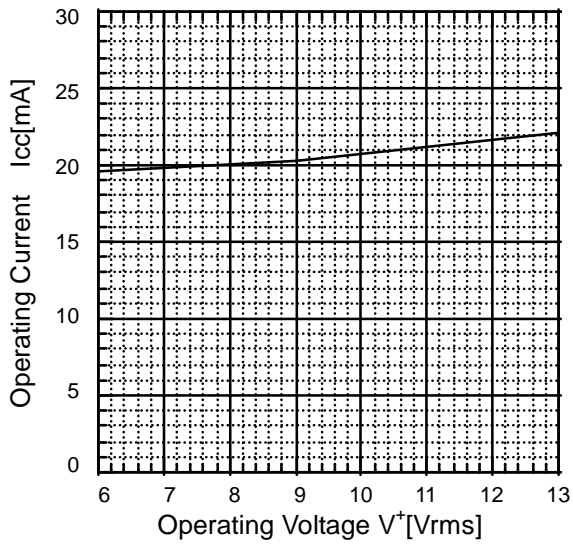

Total Harmonic Distortion vs. Input Voltage
 $f=1\text{kHz}$

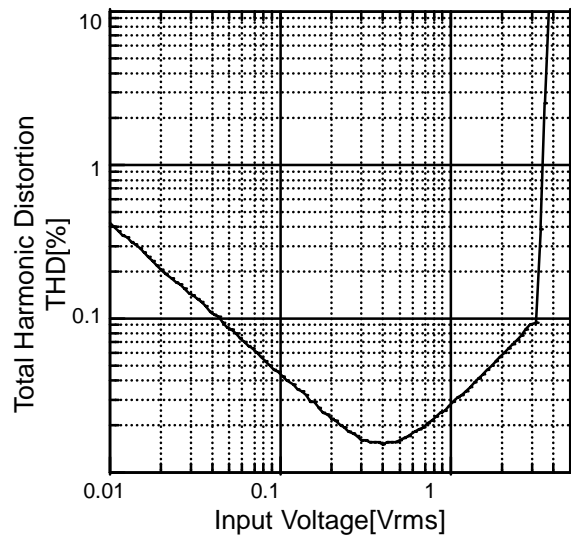

Cross Talk
 $V_{in} = 6\text{dBV}(2\text{Vrms})$

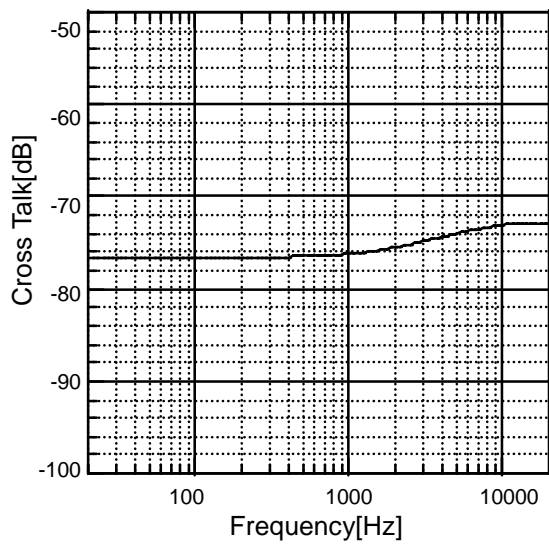

Channel Separation
 $V_{in} = +6\text{dBV}(2\text{Vrms})$

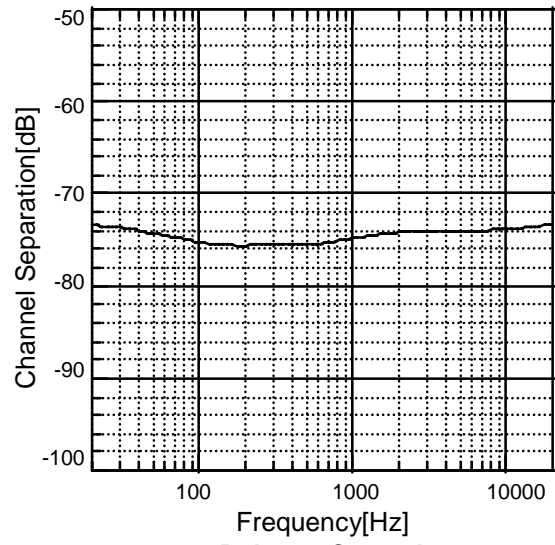

AGC

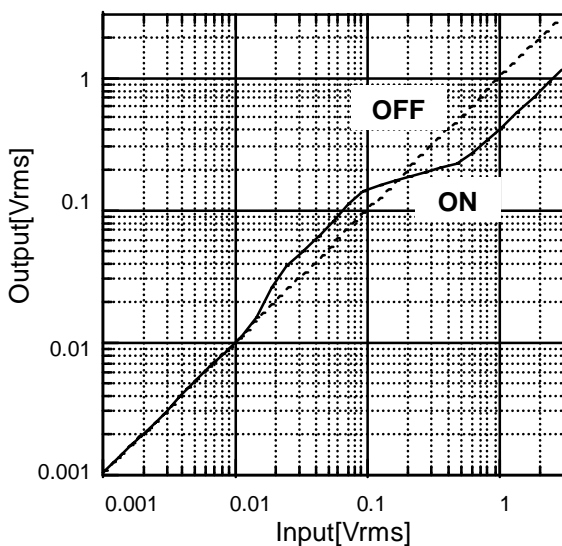

Balance Control

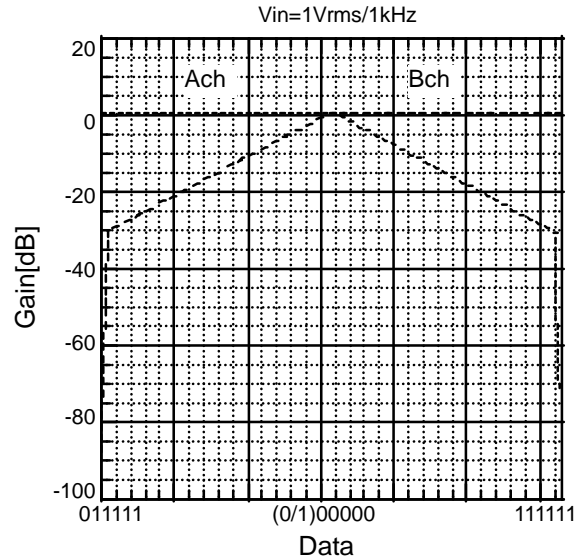

Master Volume

$V_{in} = 1V_{rms} / 1kHz$

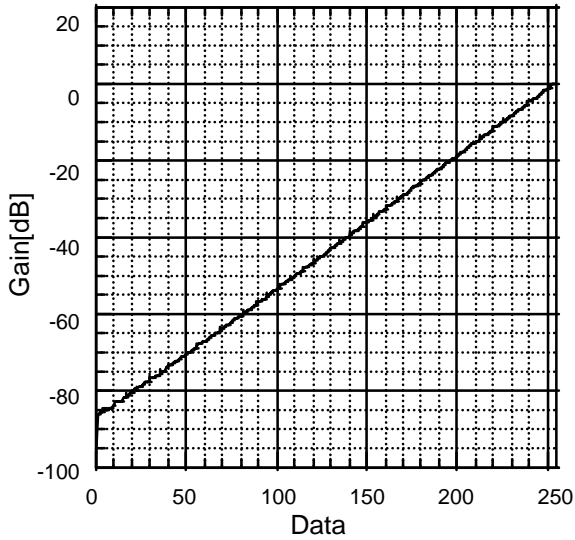

Tone Control

$V_{in} = 100mV_{rms}$

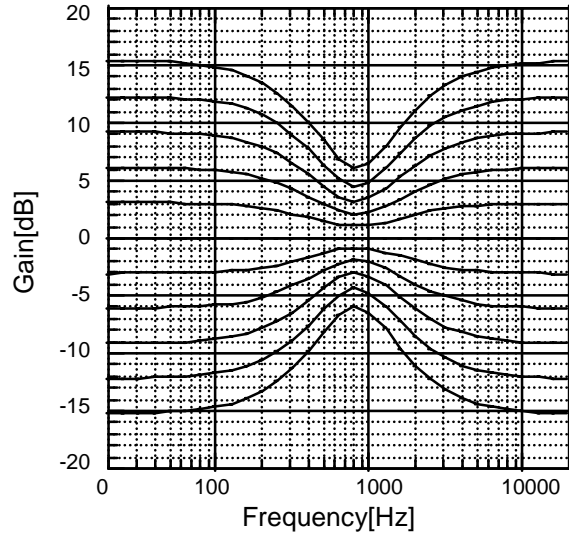

NOTE

The NJW1133A is manufactured by New Japan Radio Co., Ltd.

Purchase of I²C components of New Japan Radio Co., Ltd or one of its sublicensed Associated Companies conveys a license under the Philips I²C Patent Rights to use these components in an I²C system, provided that the system conforms to the I²C Standard Specification as defined by Philips.

[CAUTION]
 The specifications on this databook are only given for information, without any guarantee as regards either mistakes or omissions. The application circuits in this databook are described only to show representative usages of the product and not intended for the guarantee or permission of any right including the industrial rights.